

CLAMPBRO®

STRONG-ARM



**3 TONNE HEAVY DUTY LONG CHASSIS
TROLLEY JACK**

MODEL NO: CTJ3GLS

PART NO: 7623085

**OPERATION & MAINTENANCE
INSTRUCTIONS**



LS0915

INTRODUCTION

Thank you for purchasing this CLARKE 3 Tonne Heavy Duty Long Chassis Trolley Jack.

Before attempting to use this product, please read this manual thoroughly and follow the instructions carefully. In doing so you will ensure the safety of yourself and that of others around you, and you can look forward to your purchase giving you long and satisfactory service.

GUARANTEE

This product is guaranteed against faulty manufacture for a period of 12 months from the date of purchase. Please keep your receipt which will be required as proof of purchase.

This guarantee is invalid if the product is found to have been abused or tampered with in any way, or not used for the purpose for which it was intended.

Faulty goods should be returned to their place of purchase, no product can be returned to us without prior permission.

This guarantee does not effect your statutory rights.

SPECIFICATIONS

Model number	CTJ3GLS
Part number	7623085
Length (not including handle):	1305 mm
Width	322 mm
Height	305 mm
Height of lifting cup (minimum)	130 mm
Height of lifting cup (maximum)	600 mm
Weight	65 kg
Rated Load	3 tonne

SAFETY PRECAUTIONS



WARNING: THE OPERATOR MUST FOLLOW ALL INSTRUCTIONS WITHIN THIS INSTRUCTION BOOK;

WARNING: THE OPERATOR SHALL BE PROVIDED WITH ALL NECESSARY INFORMATION ABOUT TRAINING AND ABOUT PUMPING AND TRANSLATING FORCES.

1. This jack is for lifting only, do not move a load using the jack as a dolly.
2. Do not use to lift people.
3. Always inspect the jack before use. Make sure that all parts are in good condition and operating smoothly, and that no cracks or distortion is apparent. If in doubt do not use. Have the damaged parts replaced or consult your CLARKE dealer.
4. Make sure that the jack is on a firm solid base, and there is no possibility of it slipping when under load.
5. Make sure the load is taken by the full saddle and that the point of lift on the load, is strong enough to support the load adequately.
6. Do not work under the raised vehicle until it is supported by suitable means e.g. axle stands, NEVER rely on the jack to support the vehicle by itself.
7. Never push a load off the jack.
8. Ensure that all personnel are well clear of a load being raised or lowered.
9. Do not try to lift more then the rated load for the jack, (See "Specifications" on page 2.)
10. Do not use the jack if an oil leak is apparent. Consult your Clarke dealer.
11. Consult the vehicle handbook to determine the correct lifting points.
12. It is necessary that the operator watch the jack and the load during operation.
13. Check the condition of the labels regularly and replace as required.
14. The jack must be maintained and repaired in accordance with the these instructions. Such maintenance and repair must be carried out by qualified persons.
15. Do not make any adjustments or modifications to this jack or any valves on the jack.

PARTS IDENTIFICATION



BEFORE USE

ASSEMBLY

1. Insert the shaft of the handle into the handle socket.
2. Tighten the clamp bolt shown to lock the handle in position.

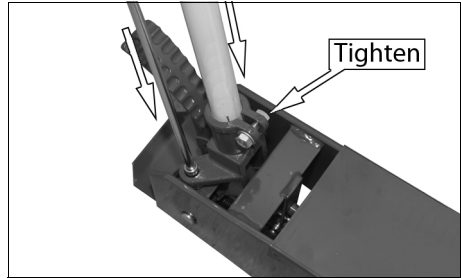

LOCKING/RELEASING THE HANDLE

To lock the handle in the upright position, put the handle lock in to the 'Locked' position as shown.

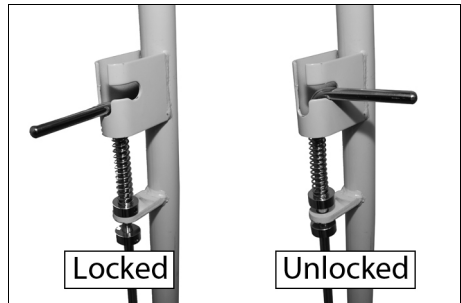

CHECK OIL LEVEL

1. With the handle in a vertical position, turn the knob on the handle counterclockwise to open the release valve.
2. Push the saddle to its lowest position.
3. Loosen the two bolts shown and lift off the cover.
4. Lever off the filler cap using a flat screwdriver.
 - Oil must be up to the edge of the hole.
5. Top up if necessary with Clarke hydraulic oil available from your local Clarke dealer (part number 3050830).

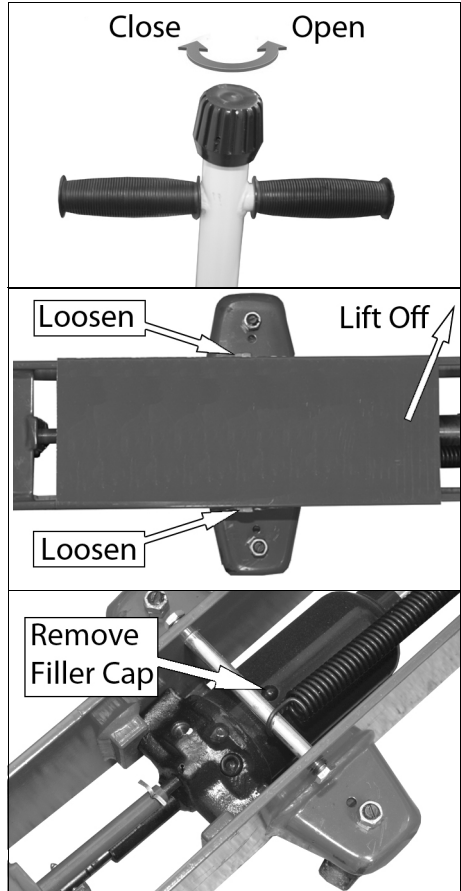

BLEED THE HYDRAULIC SYSTEM

During transportation, air can get into the hydraulic system which will cause the ram to feel "spongy".

1. Turn the knob on the handle counterclockwise to open the release valve.
 - The jack is now ready to use.
2. Pump the foot pedal 10 times to purge the air from the hydraulic system.
 - The jack is now ready to use.



POSITIONING THE JACK

- Make sure that the load is stable and on solid level ground.
 - Use suitable wheel chocks to stop the vehicle from moving.
1. Put the handle lock in to the 'Locked' position as shown.
 2. Turn the knob on the handle counterclockwise to open the release valve.
 3. Put the saddle directly below the lifting point of the vehicle (see the manufacturers handbook for the locations).
 - Make sure that there is no obstruction that will prevent a clean lift.
 - Make sure that all personnel are in a safe position before you lift the vehicle.

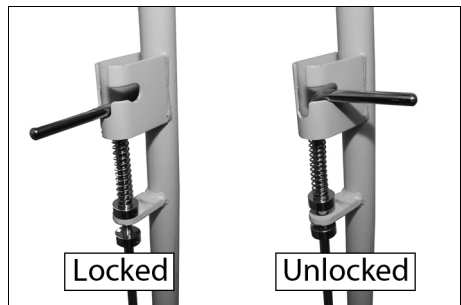

OPERATION

TO LIFT

1. Turn the knob on the handle clockwise to close the release valve.
2. Put the handle lock in to the 'Unlocked' position as shown.
3. Operate the jack by pumping the jack handle or foot pedal.

- Make sure that the saddle is in full contact with the lifting point and that there is nothing that will prevent a clean lift.

4. Put axle stands below the support points on the vehicle.

- Make sure that the axle stand is centred below the support point and are stable before full weight of the vehicle is taken on it.
- Make sure that the axle stands are in good condition and that they can hold the load.
- Ensure that the axle stands cannot move when supporting the load.
- DO NOT jerk the handle, make sure that it lowers slowly and in a controlled manner on to the axle stands

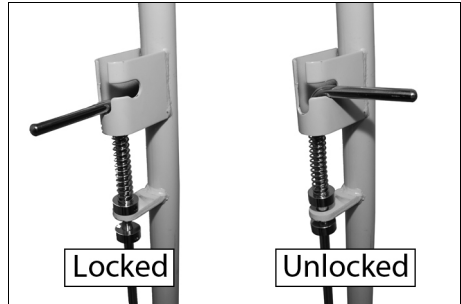

TO LOWER

1. Lift the vehicle to remove the weight from any supports.
2. Remove the axle stands or other supports from below the vehicle.
3. SLOWLY turn the knob on the handle counterclockwise to open the release valve.

NOTE: This operation must be done very slowly and in full control. DO NOT let the load lower suddenly, this could damage internal components.

4. Remove the jack from below the vehicle.

NOTE: The jack can move slightly during operation. It is important that the area is clean and free from all debris.

MAINTENANCE

1. When the jack is not in use, keep the ram fully lowered and the release valve closed.
2. Keep the jack clean and apply lubricating oil to all pivot points every three months.
3. Frequently check oil level. For procedure See "Check Oil Level" on page 6.
4. Check the pump piston and piston rod periodically for signs of corrosion. Clean exposed areas with a clean oiled cloth.
5. Change the oil once a year as follows.

CHANGING THE OIL

1. Lower the saddle fully.
2. Loosen the two cover screws and lift off the cover.

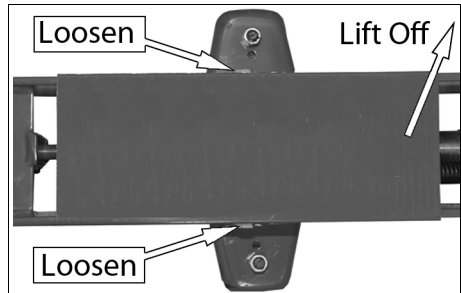

3. Lever off the filler plug using a flat screwdriver.
4. Lay the jack on its side to drain the oil into a suitable container.
5. Dispose of the oil in accordance with local regulations.
6. Fill with Clarke hydraulic oil, available from your local Clarke dealer.

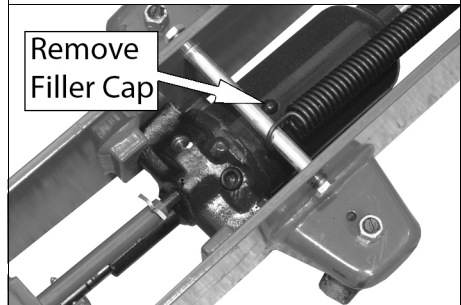

- Oil must be up to the edge of the hole.

7. Replace the oil filler cap.

STORAGE

8. Store in a dry place with the ram fully lowered. If stored for long periods, inspect at least once a year, clean and re-oil. For servicing, contact your CLARKE dealer, or CLARKE International Service Department.

TROUBLESHOOTING

PROBLEM	CAUSE	SOLUTION
Jack will not lift the rated load	Low oil level	See "Changing the Oil" on page 9.
	Release valve not closed	Turn the release knob fully clockwise
	Air in the hydraulic system	Bleed the system. See page 7
Jack lower when under load	Release valve not fully closed	Turn the release knob fully clockwise
	Air in the hydraulic system	Bleed the system. See page 7
Pump feels Spongy	Low oil level	See "Changing the Oil" on page 9.
	Air in the hydraulic system	Bleed the system. See page 7
Handle raises or flies back under load	Air in the hydraulic system	Bleed the system. See page 7
Jack will not lift full height	Low oil level	See "Changing the Oil" on page 9.
	Air in the hydraulic system	Bleed the system. See page 7
Jack will not lower completely	Return spring may be faulty	Return to your Clarke dealer for repair

If any of these remedies fail to restore your jack, consult your Clarke dealer

**For Spare Parts and Servicing, please contact your nearest dealer, or
CLARKE International, on one of the following numbers.**

PARTS & SERVICE TEL: 020 8988 7400

PARTS & SERVICE FAX: 020 8558 3622

DECLARATION OF CONFORMITY



Clarke[®]
INTERNATIONAL

Hemnal Street, Epping, Essex CM16 4LG

DECLARATION OF CONFORMITY

This is an important document and should be retained.

We hereby declare that this product(s) complies with the following directive(s):

2006/42/EC Machinery Directive.

The following standards have been applied to the product(s):

EN 1494:2000+A1:2008

The technical documentation required to demonstrate that the product(s) meet(s) the requirement(s) of the aforementioned directive(s) has been compiled and is available for inspection by the relevant enforcement authorities.

The CE mark was first applied in: 2009

Product Description: 3 Tonne Service Jack
Model number(s): CTJ3GLS
Serial / batch Number: N/A
Date of Issue: 30/06/2015

Signed:

J.A. Clarke
Director

A SELECTION FROM THE VAST RANGE OF

Clarke®

QUALITY PRODUCTS

AIR COMPRESSORS

From DIY to industrial, Plus air tools, spray guns and accessories.

GENERATORS

Prime duty or emergency standby for business, home and leisure.

POWER WASHERS

Hot and cold, electric and engine driven - we have what you need

WELDERS

Mig, Arc, Tig and Spot. From DIY to auto/industrial.

METALWORKING

Drills, grinders and saws for DIY and professional use.

WOODWORKING

Saws, sanders, lathes, mortisers and dust extraction.

HYDRAULICS

Cranes, body repair kits, transmission jacks for all types of workshop use.

WATER PUMPS

Submersible, electric and engine driven for DIY, agriculture and industry.

POWERTOOLS

Angle grinders, cordless drill sets, saws and sanders.

STARTERS/CHARGERS

All sizes for car and commercial use.



PARTS & SERVICE: 0208 988 7400

E-mail: Parts@clarkeinternational.com or Service@clarkeinternational.com

SALES: UK 01992 565333 or Export 00 44 (0)1992 565335

Clarke INTERNATIONAL Hemnall Street, Epping, Essex CM16 4LG
www.clarkeinternational.com